

Tempspec Leaf 
Vertical Stack Fan Coil Unit Models
TL, TM, TF, & TR



**INSTALLATION, OPERATION AND
MAINTENANCE MANUAL**

Table of Contents

1	Safety Warnings	3
2	Design and Take-off Precautions.....	4
3	Receiving Inspection	4
4	Installation.....	4
5	Outdoor Air Connection.....	7
6	Operating Instructions	7
7	Sequence of Operation	10
8	Maintenance	11
9	Start-up Check List	13
10	Fan Removal Procedure	13
11	Limited Warranty	14
12	Part Sales.....	14
13	Sample ETL Nameplate Label	15
14	Max Operating Conditions	15
15	Troubleshooting.....	16
16	Leaf Drywall Screw Locations.....	18
17	Standard Leaf Unit Layout.....	19
18	Model Number Reference Code	20

Table of Tables

Table 1: Fan Speed Controller Setting Reference (230V motors)	8
Table 2: Defrost Timer Adjustment.....	9
Table 3: Defrost Threshold Adjustment.....	9
Table 4: Leaf Unit standard filter sizes.....	11
Table 5: Standard Leaf Unit replacement parts.....	14
Table 6: Max Operating Conditions	15
Table 7: Standard Troubleshooting.....	16

1 Safety Warnings

WARNING

Only qualified personnel should install and service the equipment. The installation, starting up, and servicing of heating, ventilating, and air-conditioning equipment can be hazardous and requires specific knowledge and training. Improperly installed, adjusted, or altered equipment by an unqualified person could result in death or serious injury. When working on the equipment, observe all precautions on the labels that are attached to the equipment

WARNING

Proper Field Wiring and Ground Required!

Failure to follow code could result in death or serious injury. All field wiring **MUST** be performed by qualified personnel. Improperly installed and grounded field wiring poses **FIRE** and **ELECTROCUTION** hazards. To avoid these hazards, you **MUST** follow requirements for field wiring installation and grounding as described on the local electrical codes

WARNING

RISK OF ELECTRIC SHOCK. CAN CAUSE INJURY OR DEATH: DISCONNECT ALL REMOTE ELECTRIC POWER SUPPLIES BEFORE SERVICING

NOTICE

Use Copper Conductors Only!

Failure to use copper conductors could result in equipment damage as unit terminals are not designed to accept other types of conductors

CAUTION

This appliance is not intended for use by persons (including children) with reduced physical, sensory, or mental capabilities, or lack of experience and knowledge, unless they have been given supervision or instruction concerning use of the appliance by a person responsible for their safety.

“Children should be supervised to ensure that they do not play with the appliance.”

2 Design and Take-off Precautions

Always refer to the job submittal for job specific information.

Attention should be paid to the height of drywall which encapsulates ductwork in a bulkhead. Note the height of the side supply air opening shown in the submittal and ensure that the drywall does not interfere with the side wall grille. Make allowance for the 1" flange around the grille.

The TL vertical stacked fan coil unit is designed to have drywall applied directly to the face of the unit. Floor sleeves and extension sleeves through shear walls are not included.

It is important to accurately locate the floor sleeve relative to the fan coil and the drywall.

3 Receiving Inspection

The entire shipment should be inspected for damage, either readily visible or concealed. Any damage must be noted on the freight bill by the carrier's agent and Temspec notified within 24 hours.

Check riser projections at each end of the cabinet for damage that would prevent making an acceptable piping connection.

Check internal piping, coil, and valve packages for possible transit damage. If the contractor / installer deems it necessary to tighten mechanical fittings Temspec does not assume any responsibility for this procedure. It is stressed that the component manufacturer's recommended procedures be strictly followed.

Check to make sure the drain pan's overflow switch did not come loose or shift out of place during shipping

Thermostats and other accessories which have been shipped separately should be inspected for transit damage.

If the unit has a painted finish, do not remove the protective packaging material until after the unit is set in position.

3.1 Electrical Connection

It is assumed that the fan coil unit will be in a dedicated electrical circuit. If the unit is to be in a circuit which includes electrical outlets or other electrical devices, Temspec must be informed prior to releasing the units for production.

3.2 Handling

Avoid dropping or jarring the fan coil unit during offloading and moving the unit into position. Do not lift the unit using the riser pipes or H/ERV module.

Unless otherwise requested by the customer at the time

of shop drawing approval, the cabinet insulation is left intact, covering the supply air grille openings and, if applicable, the secondary return air opening to prevent dust, snow, or rain from entering the unit. The installer is responsible for cutting out the insulation and buttering the cut edge prior to installing the grilles. See section 4.6 for ducted units installation instruction.

The fan coils and risers must be kept dry, so protect them from rain and snow.

3.3 Accessories

Do not install grilles or thermostats until after the walls have been painted. Caution the painter against spraying over the labels on the front cover of the unit.

4 Installation

4.1 Identification

The fan coil unit has a label pasted on the motor cover panel for furred in units, or on a panel inside for painted units.

The label shows either the floor and riser number or the room number. The unit must be placed in the correct location in the building in accordance with the label.

4.2 Installation of Units with Risers Attached

A rectangular opening is made in the floor slab, usually sleeved before pouring the floor. Refer to the catalog or submittals for sizes.

Remove any caps in the risers. Rotate the unit from the horizontal position to vertical so that the bottom end of the risers go through the floor opening. For swagged risers the pipe inserts into the expanded end of the risers on the unit below. For plain end risers, the ends will butt together 2" is allowed in the riser length for the depth of the insertion. Shim the unit plumb to avoid standing water. It is not necessary to use a pad under the unit.

Before making the solder joint, ensure that the stub outs from the supply and return risers are centered in the slots in the cabinet. If this is not done there is considerable risk of distorting the run out when the risers expand or contract due to temperature change causing the run out to contact the edge of the slot in the sheet metal potentially causing failures or leaks. Also ensure that the condensate riser stub out is at 90° to the cabinet and that the drain hose is not kinked.

Connect the risers by soldering (not brazing) using 95/5 solder. An additional cap of 50/50 solder can be added for extra strength. Do not use brazing as this will cause the pipe to overheat and the insulation to be damaged.

Caution must be taken not to strain the coil connection. Excessive pressure in any direction can cause the coil casing to cut into the coil connection stub or cause it to bend and lead to leaks.

Ensure that the horizontal stub-out from each riser is

centered in the slot in the cabinet and that the stub-out from the riser is at 90° as it enters the cabinet, prior to soldering the risers. Anchoring the risers to the floor slabs is the responsibility of the contractor.

Riser anchoring is required for two purposes. The risers are anchored to the floor slab at one or more points in the height of the building so that they do not slip down under gravity. The second reason is to spread the expansion in opposite directions from the anchor point. Typically, risers will be anchored at the midpoint of the height of the building. If there are riser expansion loops, the anchor point will be at the midpoint between two sets of loops. For example, in a 16 story building there will be a loop on the hot water riser on floor 8 and anchors on floors 4 and 12. After anchoring, the risers are in effect attached to the building structure, so it does not matter if the plastic straps holding the risers to the unit break off after installation. **Temspec does not advise on the location or method of anchoring as this is the responsibility of the engineering company retained to design the riser system.**

Fire stopping the floor opening and making good the riser insulation of all piping not insulated by the factory is the responsibility of the contractor.

The fan coil unit has unions at the shut off valves. These fittings must be checked prior to pressure testing the system by the contractor as part of the installation procedure. Mechanical fittings can loosen during transportation and handling. If contractor /installer deem it necessary to tighten mechanical fittings Temspec does not assume any responsibility for this procedure. **It is stressed that the component manufacturer's recommended procedures be strictly followed.**

4.3 Installation of Units with Risers Loose

If the risers are shipped loose, the insulation in the riser inset holes will need to be cut. To do this simply cut an "X" in the hole to allow the stub-out to enter the unit with minimal insulation damage. Solder the isolation valves onto the appropriate risers (if required), and slide the unit into place. Connect the hoses to the valves and make the condensation connection.

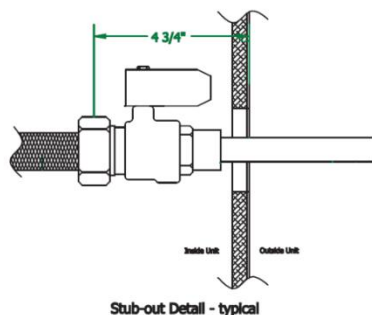

Be sure that the isolation valves do not stick too far into the unit (4-3/4" from the outside edge of the unit). This is to avoid condensation that may generate on the valves falling onto items below.

4.4 Flushing and Testing

The fan coil is normally equipped with ball type shut off valves. The unit is shipped with the ball valves open to the coil unless otherwise requested prior to units released to production.

After checking mechanical fittings inside the unit for tightness, it is recommended that the units on each riser stack are pressure tested using compressed air or nitrogen before being filled with water. Do not exceed 150PSI, or max pressure noted on the submittal. Sustained excess pressures may cause damage to components, including leaks.

Close the ball valves and flush the riser system.

Check to see if the control valve is in an open position. If it cannot be locked in an open position the unit will need to be powered on so the valve can be driven to an open position to avoid being subjected to a load greater than its close off pressure. For units with 6 way valves the process will have to be repeated for both the hot and cold water systems.

Open the supply side ball valve and bleed air from the coils. The coil has a manual air vent for this purpose. The top of each riser should also have an air vent (not provided by the factory).

Test the units and risers hydrostatically. Open the return side ball valve after testing.

Check that the strainer mesh is not choked, if there are strainers included with the unit.

City water is very corrosive to brass components. Provide water treatment as soon as the system is charged to avoid premature leaks and/or avoid failure of internal components.

The coil is pressure tested hydrostatically at the factory using a propylene glycol solution. Trace amounts of this solution are allowed to remain in the coil to ensure that the coil does not freeze during transportation. After testing on site with water the fan coil unit must not be exposed to freezing temperatures.

4.5 Drywall Installation

The fan coil model series "TL" or "TR" has a cabinet which is designed to be furred-in. Drywall can be directly attached to the cabinet, or the unit can be framed.

Direct Application – The hinged air panel must be used. It is designed to fit the 1/2" drywall flange around the return air / access opening on the unit. Use drywall screws no longer than 1 1/4" and follow the instructions in Section 16 which shows where the screws can be located to avoid damaging internal components. Do not attach screws to the H/ERV module. The sides and back can be framed.

Framing – Frame the unit using metal studs. It is preferable that the stud does not touch the fan coil cabinet so that any slight vibration which may exist is not

transferred to the stud.

Before installing the thermostat, return air panel, and grilles, the walls must be painted. Instruct the painter not to spray over the labels on the unit. After installation, dust must be vacuumed from the coil surfaces, the drain pan, the motor windings, and the cabinet insulation.

4.6 Ducted Units

Remove the supply air opening knock-out in the top panel of the fan coil. Cut out the cabinet insulation from the opening and butter the cut edge if it is glass fiber insulation. Attach the supply air duct.

Note: Supply air duct flanges are not provided by the factory.

4.7 Electrical Connection

Use Copper Supply Wires Only

Use Supply Wires Suitable for 90°C

The available voltages for the Fan Coils are: 120/60~, 208/60~, 240/60~, 277/60~

4.7.1 High Voltage

The unit has a single point connection in the electrical enclosure with either pigtails or a circuit breaker with neutral distribution block. The unit disconnect is located below the electrical enclosure on the right side. If a circuit breaker is provided, it will be in the electrical enclosure.

The electrical wiring must be in accordance with the current applicable national and local codes. A qualified electrician must carry out the work. The electrical power to the unit should be disconnected by opening the remote disconnect device prior to opening the access panel. The wiring diagram shall be followed thoroughly when making connections to the unit.

4.7.1.1 Concealed Fan Coils

Power entry is on the side of the unit. Connect power leads from the field disconnect to the pigtails provided and ground at the green screw located inside the electrical enclosure. See the job submittals for exact layout.

If a circuit breaker is used, terminate the field provided line leads directly at the circuit breaker, the neutral line is to be terminated at the power distribution block and ground at the lug located beside the circuit breaker. For 208/240VAC terminate both lines at the circuit breaker.

4.7.1.2 Finished Cabinets

Access to power is from the top right side of the unit using the half inch flex metal conduit. Connect power leads from the field disconnect to the pigtails provided at the electrical enclosure and ground at the green ground bolt provided on the electrical enclosure.

If a circuit breaker is used, terminate the field provided line leads directly at the circuit breaker, the neutral line is

to be terminated at the power distribution block and ground at the lug located beside the circuit breaker. For 208/240VAC terminate both lines at the circuit breaker.

4.7.2 Low Voltage Field Connection

Field connection of extra low voltage (ELV) must be segregated from hazardous voltage by barriers or by minimum distance of 5 inches. Low voltage connections are to be made to the terminal block mounted on the ELV bracket below the electrical enclosure on the left side of the unit (for remote mounted thermostats). For unit mounted thermostats connections are made through the opening in the front panel through a quick connect or 6 inches leads per UL60335-2-40 Clause 25.1.

4.7.3 Type and Ratings of Fuses and Circuit Breakers

Up to 30A time delay fuses are used. Up to 3 pole 100A circuit breakers are used.

4.8 Supply Air Grille Installation

The grille is a snap-in fit into the collar on the unit. If the unit has a ducted supply, side supply air grilles are provided with a balancing damper. If the unit has two unit mounted grilles and is not ducted, one of the grilles is provided with a damper. This grille is to be fitted to the opening which requires the lesser of the two air flows (for example the bedroom).

4.9 H/ERV Ducting

Remove the protective tape and attach 5" round ducting to the duct collars provided. Seal the duct join with tape. See the job specific submittal for the duct connection layout.

4.10 Return Air/Access Panel Installation

4.10.1 Panel with hinged access door and 1/2" flange

Remove the hinged door by raising it to the horizontal position and gently pull out past the hinge pins.

Remove the top pair of screws from the motor cover panel.

Align the bottom and hook on over the bottom collar of the fan coil unit. Tilt the panel up so that it is flush against the unit/drywall.

Secure the panel by reinstalling the machine screws through the slotted tabs on the panel frame.

Reinstall the hinged filter access door using the same technique used to remove it.

4.10.2 Panel with hinged access door and 2" flange

Remove the hinged door by raising it to the horizontal position and gently pull out past the hinge pins.

Align the bottom and hook on over the bottom collar of the fan coil unit. Tilt the panel up so that it is flush against the drywall.

Secure the frame to the flange by fitting sheet metal screws through the holes on the edge of the frame. Do not overtighten the screws.

4.10.3 Perimeter Panel

Insert the panel into the collar on the fan coil unit so that the panel frame is against the drywall.

Open the hinged access panel and secure the frame by fitting sheet metal screws through the holes on the edge of the frame (six for TL units and eight for TR units). Do not overtighten the screws.

4.11 Top Extension for Painted Units

If a top extension has been provided to trim the unit up to the ceiling, the extension overlaps the top of the unit by 1-1/2". Use sheet metal screws to attach the extension directly to the unit.

4.12 Riser Pipe Cover for Painted Units

If a riser cover has been provided, it is installed after the floor opening has been fire-stopped. A cover support bracket and a wall bracket are provided for the cover installation. The support bracket screws into the side face of the unit close to the front, recessed by the thickness of the cover. The wall bracket screws into the wall where the cover will align with the wall. The cover snaps into the support bracket and screws to the wall bracket. Refer to the submittal for illustrations of the bracket arrangements.

4.13 Thermostat Installation

4.13.1 Unit mounted thermostat

For thermostats provided by Temspec, connect the wires from the thermostat to the wire harness usually inside the electrical compartment using the plug provided. Mount the thermostat directly to the unit.

For thermostats provided by others, connect the provided wires to the thermostat (see wiring diagram for wire identification). Mount the thermostat directly to the unit.

4.13.2 Remote mounted thermostat

Run low voltage wires from the 24V thermostat on the wall back to the terminal strip inside the unit.

5 Outdoor Air Connection

Temspec Leaf units may have an outdoor air connection located at the bottom of the unit below the drain pan.

5.1 Manual Damper

One option with an outdoor air option is to have a manual damper in the unit. This allows for manual balancing of the amount of outdoor air coming into the unit.

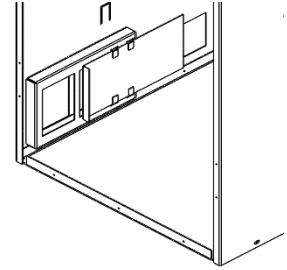

The standard opening is 4"x6". All unit sizes have the opening located 1-1/4" from the side of the unit, and 1-3/8" up from the bottom of the unit. An example for the left side is to the right. The options for locations are left, right, back-right, and back-left.

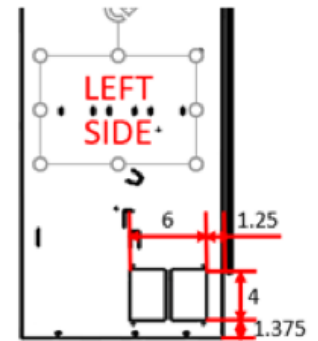

5.2 Automatic Damper

Another option is to have the damper automatically controlled to shut off the outdoor air when it is not desired. Normally when the room is unoccupied or when the outdoor air temperature is too low.

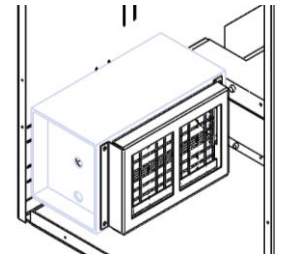

The opening for the automatic damper is 4"x6". The opening is located 1-1/4" from bottom of the unit. For openings on the left or right the opening is located 1-13/16" back from the front of the unit. For units with back openings, the opening is located 4-1/2" from the side with the risers.

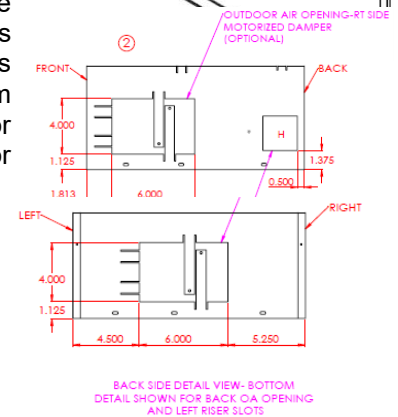

6 Operating Instructions

Turn on the disconnect switch located behind the fan enclosure cover to the "On" position.

6.1 Standard Digital Programmable Thermostat (Spartan)

Select the mode, RUN, HALT, or STOP, by pressing the "Mode" button

Adjust the setpoint to desired temperature setting using the up/down arrow buttons.

Toggle the “Fan” button between auto and continuous. The fan speed will vary based on the difference between room temperature and room setpoint. In Auto mode, the fan will shut off when there is no heating/ cooling demand, this is the most economical operating mode. In continuous the fan will run at a low speed.

The “On/Off” button turns the unit on or off.

The thermostat allows for 7 day scheduling. The battery back-up lasts for 5 years.

See thermostat operating instructions for further information. Refer to thermostat operating instructions for other thermostats used.

Note: the thermostat must have 0-10VDC fan signal to control fan speed. A motor speed board model SPDM will allow the contractor to adjust the maximum fan speed if the factory set point is not suitable. If a thermostat with a 3-speed fan switch is used, a digital to analogue interface board model EVO/10Y-4Spd must be used to convert the fan signal to a 0-10VDC.

6.2 Adjusting the maximum airflow

A motor speed board in the unit will allow adjustment of the fan speeds if the factory settings are not suitable.

Caution: Adjusting fan RPM to a higher speed may result in excessive air flow noise.

The maximum airflow is factory set to the closest nominal design airflow, or to the safest the low speed to work with electric heat but can be field adjusted if needed.

With a 0-10VDC thermostat fan signal, the max CFM can be adjusted by adjusting the blue knob on the fan board in the electrical box. See the picture and reference chart to the left. To increase the maximum airflow, turn the adjustment clockwise to increase maximum airflow and counterclockwise to reduce it. The chart below indicates the % flow, airflow, relative to cabinet size and external static pressure.

If a 3 speed fan control thermostat is used, the airflow for each speed is factory set to be 50% on low speed, 75% on medium speed, and 100% on high speed, or 70%, 85%, and 100% for units with electric heat. Each motor speed airflow may be adjusted by turning the adjustment dials on the EVO board. Call 1=low speed, call 2=medium speed and call 3=high speed.

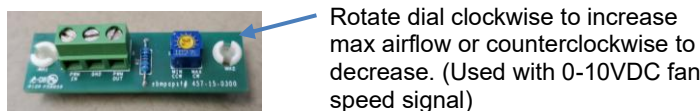

Figure 1: Max CFM Adjustment Board

Table 1: Fan Speed Controller Setting Reference (230V motors)

Cabinet Size	CFM/ L/S	Dial Position @ Direct Supply	Dial Position@ 0.2"/ 50pa ESP	Dial Position@ 0.4"/ 100pa ESP
300/400	200/94	60%	-	-
300/400	300/145	70%	85%	-
300/400	400/190	90%	100%	-
600/800	500/235	60%	70%	80%
600/800	600/285	70%	75%	85%
600/800	700/330	80%	85%	95%
600/800	800/380	90%	95%	-
1000/1200	900/425	55%	65%	70%
1000/1200	1000/470	65%	70%	75%
1000/1200	1100/520	75%	75%	80%
1000/1200	1200/565	80%	85%	90%

Warning: if the maximum CFM is adjusted to a value above the design airflow, excessive air noise could occur



Rotate dial(s) clockwise to increase max airflow or counterclockwise to decrease. Call 1, 2 & 3 are used with 3 speed fan thermostats. (Call 4 not used) No call must be at zero flow.

Figure 2: EVO 4-Spd CFM Adjustment Board

6.3 H/ERV Fan Adjustment

To adjust the normal operating speed of the fan, use the potentiometers located on the control board. Clockwise increase the speed and counterclockwise decrease the speed. P1 = SP FAN, P2= EX FAN.

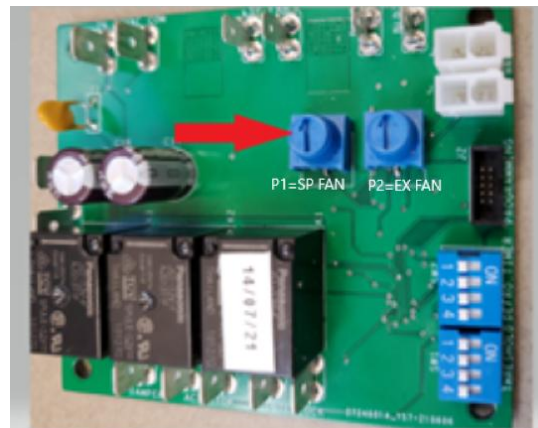

Figure 3: H/ERV module fan adjustment dials

6.4 H/ERV Defrost Timer Adjustment

The defrost timer is adjustable with the timer dip switch selection (SW2). The below chart shows the switch locations and the associated settings.

Table 2: Defrost Timer Adjustment

SW2 Setup (1,2,3,4)	Defrost Timer
OFF, OFF, OFF, OFF (DEFAULT)	Defrost on 5mins, off 5mins
ON, OFF, OFF, OFF	Defrost on 1mins, off 9mins
OFF, ON, OFF, OFF	Defrost on 2mins, off 8mins
ON, ON, OFF, OFF	Defrost on 3mins, off 7mins
OFF, OFF, ON, OFF	Defrost on 4mins, off 6mins
ON, OFF, ON, OFF	Defrost on 5mins, off 5mins
OFF, ON, ON, OFF	Defrost on 6mins, off 4mins
ON, ON, ON, OFF	Defrost on 7mins, off 3mins
OFF, OFF, OFF, ON	Defrost on 8mins, off 2mins
ON, OFF, OFF, ON	Defrost on 9mins, off 1mins

6.5 H/ERV Fan Purge mode adjustment

By default, the purge mode speeds both fans up to full speed. To adjust the fan speed, power off the unit, set SW2 to ON, ON, ON, ON and power up the unit. This will enter the control board into the “Purge Mode Set” function. Adjust the potentiometers to the proper fan speed for the site application. Power the unit back off and reset SW2 to the original settings and power the unit back on to have it run like normal. This will cause the “Normal Mode” fan speeds to have to be readjusted.

6.6 H/ERV Defrost Threshold Adjustment

The defrost threshold temperature is adjustable with the threshold dip switch selection (SW1). The below chart shows the switch location and the associated settings.

Table 3: Defrost Threshold Adjustment

SW1 Setup (1,2,3,4)	Defrost Threshold
OFF, OFF, OFF, OFF (DEFAULT)	-5C (23F)
ON, OFF, OFF, OFF	0C (32F)
OFF, ON, OFF, OFF	-2C (28.4F)
ON, ON, OFF, OFF	-4C (24.8F)
OFF, OFF, ON, OFF	-6C (21.2F)
ON, OFF, ON, OFF	-8C (17.6F)
OFF, ON, ON, OFF	-10C (14F)
ON, ON, ON, OFF	-12C (10.4F)
OFF, OFF, OFF, ON	-14C (6.8F)
ON, OFF, OFF, ON	-16C (3.2F)
OFF, ON, OFF, ON	-18C (-0.4F)
ON, ON, OFF, ON	-20C (-4F)

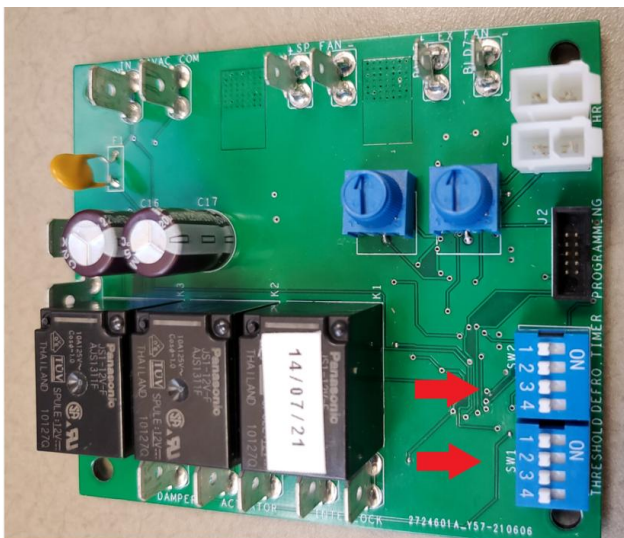

Figure 4: H/ERV module dip switches

7 Sequence of Operation

Note: always refer to wiring diagram on the motor cover panel (concealed fan coil) or electrical box (finished fan coil) to determine the model and type of fan coil.

7.1 2-Pipe Heating/Cooling Units

The control valve is activated by the cool and heat outputs from the thermostat which are connected to an aquastat.

On a call for cooling from the thermostat and the water temperature is less than 65F, the aquastat energizes the control valve. If the water temperature rises above 85F, the aquastat de-energizes the control valve.

On a call for heating from the thermostat and the water temperature is greater than 85F, the aquastat energizes the control valve. If the water temperature drops below 65F, the aquastat de-energizes the control valve.

The aquastat has black, yellow, and orange wire leads. The switch closes for heating at 85F +/- 5F through BL and ORA and cooling at 65F +/- 5F through BL and YEL.

7.2 2-Pipe Heating/Cooling Auxiliary Electric Heat Unit

The control valve and electric heat relay are activated by the cool and heat outputs of the thermostat which are connected to two aquastats labeled A1 and A2 on the wiring diagram.

On a call for cooling from the thermostat and the water temperature is less than 65F, the A1 aquastat energizes the control valve. If the water temperature rises above 85F, the aquastat deenergizes the control valve.

On a call for heating from the thermostat and the water temperature is more than 85F, the A1 aquastat energizes the control valve. If the water drops below 65F, the aquastat de-energizes the control valve and the A2 aquastat energizes the electric heat relay.

7.3 2-Pipe Heating/Cooling Total Electric Heat Unit

The control valve and electric heat relay are activated by the cool and heat outputs of the thermostat. No aquastats are used.

On a call for cooling from the thermostat, the thermostat energizes the chilled water control valve.

On a call for heating from the thermostat, the thermostat heat output energizes the electric heat relay. The control valve remains closed.

7.4 2-Pipe Cooling Only Unit

The chilled water control valve are activated by the cool outputs of the thermostat. The thermostat should be locked into cooling mode only. No aquastats are used.

On a call for cooling from the thermostat, the thermostat cool output energizes the chilled water control valve.

7.5 4-Pipe Heating/Cooling Unit

The hot water control valve and chilled water control valve are activated by the cool and heat outputs of the thermostat. No aquastats are used.

On a call for cooling from the thermostat, the thermostat cool output energizes the chilled water control valve.

On a call for heating from the thermostat, the thermostat heat output energizes the hot water control valve

Note: See submittal for more information specific to the unit and refer to the wiring diagram on the motor cover.

7.6 H/ERV Normal Running Mode

When the H/ERV control is turned on, both module fans will start and run at the selected speed (adjustable on site) and the internal damper will open.

7.7 H/ERV Purge Mode

When the PURGE mode is selected, the fans will run at high speed. An optional accessory is the remote mount purge timer. This is a 20/40/60min push button timer. Push the button once for 20mins, twice for 40mins, three times for 60mins, and four times to stop activation.

7.8 H/ERV Defrost Mode

The defrost mode activates to prevent frost buildup on the core due to cold outdoor air. When the temperature on the outdoor side of the core reaches below the threshold (-5C (23F) is default), the unit will enter defrost mode. During this mode, the internal damper will close, and recirculation will occur for a split of a 10 minute interval (5 mins is default), during this mode both fans will run at low speed. When it is not recirculating, the unit will run in Normal Mode.

7.9 H/ERV Freeze Protection

When the temperature sensor located on the coil reads below 2.8C (37F) the unit will go into a freeze protection mode to try and prevent the coil from freezing. In this mode, the H/ERV and Fan Coil fans will stop, the H/ERV damper will close, and the hot water valve (or only valve for 2-pipe systems) will open. The unit will stay in this mode until a temperature of 12.8C (55F) is reached.

8 Maintenance

Always isolate the unit electrically before removing the front access panel. Do this by opening the circuit breaker (or other switching device) in the distribution panel in the suite. Do not use the fan switch as a means of isolation. There is a high risk of electrocution if the unit is improperly isolated. If in doubt, have a qualified electrician perform the service work.

Ensure that the fan has stopped rotating before proceeding to work within the unit.

If the unit is equipped with a fuse or circuit breaker, do not change out either of these devices with ones of a higher Amp rating. The purpose of a fuse or circuit breaker is to protect the wiring to the unit.

Take care when working inside the unit. Sheet metal components may have sharp edges.

8.1 Every 3 Months

8.1.1 Check/replace the Return Air filter

The filter can be one of two types: a 1" thick cardboard framed type or a metal frame with filter media attached.

To access the filter, grasp the bottom of the hinged door and pull sharply forwards, and lift the door to the horizontal position, or open the perimeter panel door. The filter is now accessible and is removed by sliding upwards out of the channels attached to the inside of the grille on Return Air flanges.

Table 4: Leaf Unit standard filter sizes

Part	300/400	600/800	1000/1200
TL/TM Unit	14"x25"x1" (355x635x25)	14"x25"x1" (355x635x25)	16"x25"x1" (405x635x25)
TF Unit	14"x25"x1" (355x635x25)	16"x25"x1" (405x635x25)	16"x25"x1" (405x635x25)
TR Unit	14"x25"x1" (355x635x25)	14"x25"x1" (355x635x25)	18"x25"x1" (455x635x25)

8.1.2 Check/ clean the H/ERV filters

The H/ERV filter are an electrostatic washable filter to protect the core from any debris.

To access these filters follow the instructions below. Please note a step stool may be required for proper access.

1. Remove the upper cover panel by removing the two screws (1/4" hex head) and pulling the panel towards you and down.

2. Remove the lower motor panel by removing the four screws (1/4" hex head) and pulling the panel towards you and up.
3. Turn off the disconnect switch below the electrical enclosure.

Warning: Do not reach into the unit until disconnect is switched off.

4. Remove the two screws on the module access panel (#2 Phillips or #2 "red" Robertson) and the two bars, if present, by pushing up out of the bottom bracket and then pulling out and down of the top bracket.

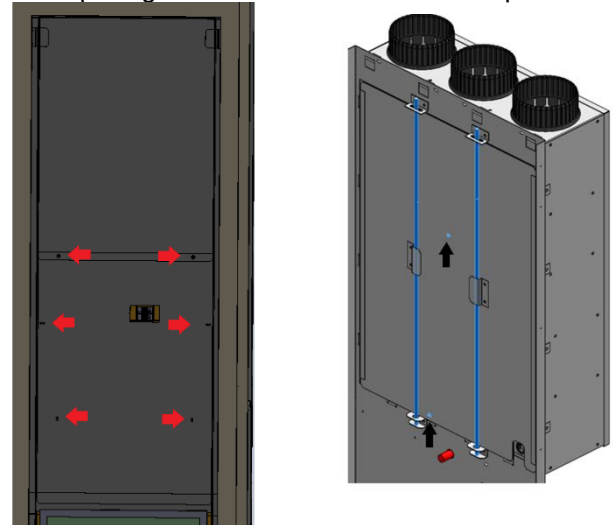

Figure 5: Access to H/ERV module. Left - screw location on front covers of fan coil. Right - screws and bars on module cover inside the fan coil.

5. Remove the closed cell insert on top of the core. Pull out the top part that is wedged between the block-off and the top of the core. Tape may have been applied during installation to avoid movement while installing.

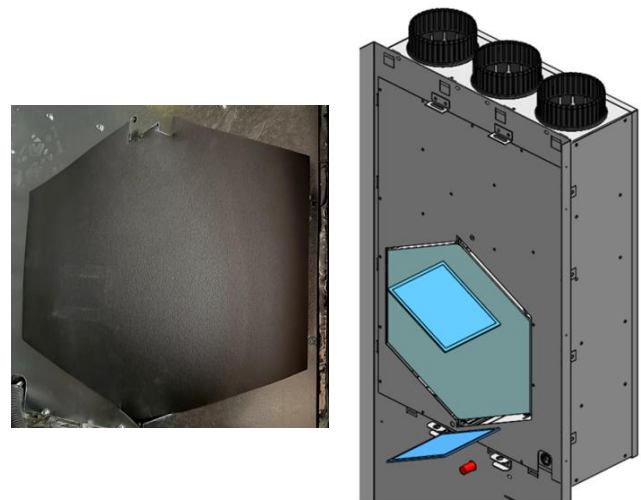

Figure 6: Left - proper installation of closed cell insert. Right - filter location inside module

Once inside the module follow the below directions to clean the core filters.

1. Remove the core filters by pulling them out towards you (needle nose pliers may help)
2. Soak the filters with water and a mild soap. Lightly shake and dry the excess water off of the filter before re-installing.

After cleaning follow instructions below to close up the module and unit properly.

1. Push the core back into place. Ensure the core tabs are in their guide channels. Ensure the temperature sensor did not get wedged behind the core
2. Push the filters back into their guides
3. Reinsert the closed cell insert. Ensure the top and bottom are wedged between the block-off panel and the core
4. Install the module access panel.
 - a. Align the bottom of the panel with the brackets for mounting the rods and centered in the cabinet.
 - b. Insert and tighten the two screws. To make alignment easier, insert and lightly thread both screws before fully tightening. The screwdriver or small rod can be used to help with initial screw alignment
 - c. If applicable, reinstall the rods. Push them up through the upper bracket openings, push them against the panel and down into the bottom brackets
5. Reinstall the unit cover panels
 - a. Install and secure the bottom panel before installing and securing the upper panel.

Note: The module motors and damper actuator do not require maintenance or additional lubrication. Access to them is by removing the block-off panel and should be done by a qualified technician.

8.2 Annually (before the start of the cooling season)

8.2.1 Check/ Clean Cabinet and Coil

Remove the return air/access panel from the wall.

Vacuum the drain pan and check that the drain outlet is not blocked. Pour water into the pan and check that it drains quickly. If it appears to be partly blocked, remove, and clean the drain hose beneath the pan.

If the coil surface is dirty, vacuum the surface which faces the room. Take care not to damage the aluminum fins on the coil. If the fins are flattened, the performance of the unit will be reduced.

Inspect the surface of the cabinet liner for evidence of

dampness. The liner should be completely dry in all areas. Vacuum excessive dust from the liner, taking care not to damage the black acrylic coating on the liner. Do not run the unit if the liner is damp as this can promote mold growth. Determine the cause of the dampness. If there is evidence of mold growth it might be necessary to replace part or all of the liner. If in doubt consult a remediation specialist.

Fan, fan motor, control valve(s), electric heater, drain pan over-flow switch, and thermostat do not require routine maintenance.

Note: the fan motor has sealed bearings and does not require additional lubrication.

8.2.2 Check/ Clean the H/ERV Core

Note: Refer to section 8.1.2 for instructions on opening up the module to access the core and closing it back up when complete.

Once the module is accessible and open follow the instructions below.

Check the H/ERV core for debris and clean if needed.

1. Remove the core by pulling it out towards you. Check the H/ERV core for debris and clean if needed by continuing with steps 2 through 6
2. Rinse with water from all sides
3. Use a cup to pour a mild soap and water mixture through each opening of the core
4. Use a soft brush to clean the housing, inlets, and outlets, being careful not to damage the membrane
5. Rinse the soap with clean water
6. Dry the core with a dry cloth and let sit for at least one day in a well-ventilated space before reinstalling the core into the unit

9 Start-up Check List

9.1 Receiving & Inspection

- Unit received undamaged
- Unit received as ordered

9.2 Handling & Installation

- Unit installed level & square
- Proper access is provided
- Proper over-current protection is provided
- Unit protected from dirt & foreign matter

9.3 Cooling/Heating Connections

- Protect valve package components from excessive heat
- Pressure-test all piping for leaks
- Install drain lines and traps as required
- Insulate all piping as required
- Connect risers from master to secondary units if required
- Insulate any uninsulated sections of the risers
- Connect risers to piping package if shipped separately or supplied by others

9.4 Electrical Connections

- Refer to unit wiring diagram
- Connect incoming power service
- Install and connect “shipped loose” components like thermostat

9.5 Unit Start-up

- Check for free and proper fan rotation
- Record electrical supply voltage and amperage
- Check all wiring for secure connections
- Close all unit isolation valves
- Flush water systems
- Open all isolation valves after system flush
- Check the strainer (if applicable) after flushing the system for debris
- Vent water systems as required
- All duct work and grills are in place
- Filters are in place
- Start blowers, pumps, chillers etc.
- Check all units for electrical over-load
- Check all duct work and units for air leaks

- Balance water systems as required
- The Erie control valve can be “locked” open by manually positioning the lever on the back of the valve actuator. Ensure this released so after flushing to allow the valve to be controlled by the thermostat
- Balance air system as required
- Record all final settings for future reference
- Check piping and walls for severe vibration
- Check all dampers for proper operation (if any)
- Verify heating and cooling operation
- Ensure all access panels and grilles are securely in place
- Verify condensate is flowing
- Ensure the condensate switch did not shift during shipping or installation

10 Fan Removal Procedure

10.1 300/400 Units

- Remove the Return Air Panel and the motor cover
- Disconnect power by switching off the disconnect with the main unit disconnect
- Open the electrical enclosure and disconnect all motor wires and feed back into the motor chamber
- Remove the screws connecting the motor base to the fan bulkhead
- Slide the assembly out through the front opening making sure the motor wires are not caught on anything
- To install a new fan, follow the above steps in reverse

10.2 600/800 Units

- Remove the Return Air Panel and the motor cover
- Disconnect power by switching off the disconnect with the main unit disconnect
- Open the electrical enclosure and disconnect all motor wires and feed back into the motor chamber
- Unscrew the nuts for the frame support legs (found underneath the fan bulkhead)
- Once all four nuts are removed the fan and frame can be lifted and removed out of the front opening
- To install a new fan, remove the base from the new assembly then follow the above steps in reverse order while making sure to align the motor wires properly

10.3 1000/1200 Units without H/ERV module

- Remove the Return Air Panel and the motor cover
- Disconnect power by switching off the disconnect with the main unit disconnect
- Open the electrical enclosure and disconnect all motor wires and feed back into the motor chamber
- Remove the screws connecting the motor base to the fan bulkhead
- Slide the assembly out through the front opening making sure the motor wires are not caught on anything
- To install a new fan, follow the above steps in reverse

10.4 1000/1200 Units with an H/ERV module

- Remove the Return Air Panel and the motor cover
- Disconnect power by switching off the disconnect with the main unit disconnect
- Open the electrical enclosure and disconnect all motor wires and feed back into the motor chamber
- Unscrew the nuts for the frame support legs (found underneath the fan bulkhead)
- If the unit has electric heat, the heater needs to be disconnected and removed.
- Once all four nuts are removed, lift the fan up over the electrical box and out of the opening
- To install a new fan, remove the base from the new assembly then follow the above steps in reverse order while making sure to align the motor wires properly

Contact Temspec if more information is needed.

11 Limited Warranty

TEMSPec INCORPORATED warrants the equipment from factory defects in material or workmanship for a period of eighteen months from the date of shipping.

For this warranty to be valid, the unit(s) must be installed and maintained in accordance with the manufacturer's printed instructions. It does not cover parts damaged by vandalism, improper installation, maintenance, or abuse.

Should any replacement parts be required within the warranty period, they will be supplied at no charge, freight prepaid to the jobsite. The cost of labor or incidental expenses incurred in the repair or replacement of parts does not form part of this warranty.

The warranty period commences from the date of shipment, except when otherwise agreed at the point of sale (see specific warranty terms and conditions for details).

12 Part Sales

Table 5: Standard Leaf Unit replacement parts

Part	300/400	600/800	1000/1200
TL Fan Coil Filter	FPY 14125	FPY 14125	FPY 16125
TF Fan Coil Filter	FPY 14125	FPY 16125	FPY 16125
TR Fan Coil Filter	FPY 14125	FPY 14125	FPY 18125
Fan Coil Fan Assembly (120V)	BFE 0251017	BFE 0281017	BFE 0311035
Fan Coil Fan Assembly (200- 277V)	BFE 0252008	BFE 0282017	BFE 0313050
Fan Coil Valve 2- Pos Actuator (Normally Open)	RVM 00231 OR RVM 00230A	RVM 00231 OR RVM 00230A	RVM 00231 OR RVM 00230A
Fan Coil Valve 2- Pos Actuator (Normally Closed)	RVM 00131 Or RVM 00130A	RVM 00131 Or RVM 00130A	RVM 00131 Or RVM 00130A
E/HRV Fan	BFE 0131006	BFE 0131006	BFE 0131006
E/HRV Filter	FRE 06006	FRE 06006	FRE 06006
E/HRV Damper Actuator	EAD 28110S	EAD 28110S	EAD 28110S

Unit layout can be seen below

For other job specific parts please contact Temspec Technical Support by phone:1-800-TEMSPec or (905)-670-3595 or by email at service@temspec.com.

For replacement parts, please contact Temspec and ask for "parts sales". We can be reached by phone:1-800-TEMSPec or (905)-670-3595 or by email at sales@temspec.com.

Be sure to include the unit serial number located on the unit nameplate.

13 Sample ETL Nameplate Label



MIN. INSTALLATION CLEARANCE TO COMBUSTIBLE SURFACE IS 0"
 LE DEGAGEMENT MINIMUM D'UNE SURFACE COMBUSTIBLE EST DE 0 POUCES
 USE COPPER SUPPLY WIRES
 UTILISER DES FILS D'ALIMENTATION EN CUIVRE

Floor:
 Riser:
 Room:



Conforms to UL Std. 1995 & Certified to CSA Std. C22.2 No. 236

MODEL No. <input type="text"/>	SERIAL No. <input type="text"/>
No. DE MODELE	No. DE SERIE
MIN. CIRCUIT AMPACITY <input type="text"/> A	MAXIMUM OVERCURRENT PROTECTIVE DEVICE <input type="text"/> A
AMFACITE DE CIRCUIT MINIMUM	MAXIMAL DU DISPOSITIF DE PROTECTION CONTRE LES SURINTENSITES
ELEC. RATING <input type="text"/> V/PH/Hz	SHORT CIRCUIT CURRENT RATING <input type="text"/> kA
CAPACITE ELECTRIQUE	COURANT DE COURT-CIRCUIT NOMINAL
COMPRESSOR <input type="text"/> RLA <input type="text"/> LRA	MAX. EXT. S.P. <input type="text"/> IN. H ₂ O
COMPRESSEUR	PRESSION STATIQUE EXTERIEURE MAXIMUM
COND./EXHAUST FAN <input type="text"/> X <input type="text"/> HP <input type="text"/> FLA	MAX. INLET WATER TEMP. <input type="text"/> °F
VENTILATEUR A CONDENSATION/DECHAPPEMENT	TEMPERATURE MAXIMALE DE L'EAU D'ENTREE
SUPPLY FAN <input type="text"/> X <input type="text"/> HP <input type="text"/> FLA	MAX. STEAM PRES. <input type="text"/> PSIG
VENTILATEUR DE SOUFFLAGE	PRESSION MAXIMUM DE VAPEUR
O/A INTAKE FAN <input type="text"/> X <input type="text"/> HP <input type="text"/> FLA	MAX. OUTLET AIR TEMP. (ELEC. HEAT ONLY) <input type="text"/> °F
VENTILATEUR D'ADMISSION DE L'AIR EXTERIEUR	TEMP. DE SORTIE MAX. DE L'AIR (CHAUFF. ELEC. SEULEMENT)
ELECTRIC HEATER <input type="text"/> V/PH/Hz <input type="text"/> kW	CONDENSATE PUMP <input type="text"/> A
RADIATEUR ELECTRIQUE	POMPE A CONDENSAT
REFRIGERANT TYPE <input type="text"/> LBS	ENERGY RECOVERY WHEEL <input type="text"/> A
TYPE DE REFRIGERANT	ROUE A RECUPERATION D'ENERGIE
PRESSURE HIGH SIDE <input type="text"/> PSIG LOW SIDE <input type="text"/> PSIG	UV LIGHT <input type="text"/> A
PRESSION COTE HAUT COTE BAS	LUMIERE ULTRA-VIOLETTE
REMOTE CONDENSER TYPE <input type="text"/>	
GENRE DE CONDENSATEUR A DISTANCE	
REFERENCE CODE <input type="text"/>	OA ELECTRIC HEATER <input type="text"/> V/PH/Hz <input type="text"/> kW
CODE DE REFERENCE	RADIATEUR ELECTRIQUE DE L'AIR EXTERIEUR

V4M

14 Max Operating Conditions

Table 6: Max Operating Conditions

Condition	Value
Max Water Temperature	200F
Min Water Temperature	40F
Max External Static Pressure Tested	0.5" W.C.
Max Operating Water Pressure	150PSI
Min Distance to Structure	0" (see drywall screwing instructions)

15 Troubleshooting

Table 7: Standard Troubleshooting

Fault	Common Causes	Troubleshooting	Solution
Supply Fan fails to start	Motor not receiving power	Ensure the unit is supplied with correct line voltage	Power on main power supply and unit power switch
		Ensure all wiring connections are correct and secure	Fix any loose connections
	Motor is not receiving control signal	Ensure controller is powered	Verify 24VAC from transformer to controller. Replace controller if power is present but it is not powering up
		Ensure controller is sending a proper signal	Verify the controller programming/ setup
		Ensure H/ERV Control board is powered and not in Freeze Protection mode	Check wiring connections and ensure the coil temperature sensor is above 12.8C (55F)
Failed Motor	Ensure motor is receiving power and control signal	Replace motor	
H/ERV Fan Fail to Start	Motor not receiving power	Ensure the unit is supplied with correct line voltage	Power on main power supply and unit power switch
		Ensure all wiring connections are correct and secure	Fix any loose connections
	Motor is not receiving control signal	Ensure the H/ERV control board is powered	Verify 24VAC from transformer to the control board
		Ensure the control signal is not turned down too low	Adjust the potentiometers on the board.
		Ensure H/ERV Control board is powered and not in Freeze Protection mode	Check wiring connections and ensure the coil temperature sensor is above 12.8C (55F)
Failed Motor	Ensure motor is receiving power and control signal	Replace motor	

Fault	Common Causes	Troubleshooting	Solution
Control Valve Fails to Open	Actuator is not receiving proper signal	Ensure controller is sending a proper signal	Verify the controller programming/ setup
		Aquastat is blocking signal to valve (2-pipe units only)	Verify the water temperature in the coil is above 85F for heating or below 65F for cooling. Replace Aquastat if it has failed
		Ensure H/ERV Control board is powered and not in Freeze Protection mode (will force open HW actuator in 4-pipe or the only valve in 2-pipe)	Check wiring connections and ensure the coil temperature sensor is above 12.8C (55F)
	Failed Actuator	Ensure the actuator is receiving proper signal	Replace Actuator
Electric Heat Coils Fails to Operate	Heater is not receiving power	Ensure the unit is supplied with correct line voltage	Power on main power supply and unit power switch
		Ensure controller is sending a proper signal	Verify the controller programming/ setup
		Aquastat is blocking signal to valve (2-pipe changeover units only)	Verify the water temperature in the coil is below changeover. Replace Aquastat if it has failed
		Ensure the air differential pressure switch in not blocking the signal	Ensure the fan is running and the intake tubing for the switch is in place and not blocked. Replace the switch if failed
		Ensure the manual temperature limit switch is not tripped	Press switch to reset. Caution: could be very hot, switch trips at 175F
	Failed heat coil	Ensure the actuator is receiving proper voltage	Replace heat coil

16 Leaf Drywall Screw Locations

☒ -- DO NOT PENETRATE CABINET WITH DRYWALL SCREWS IN SHADED AREAS SHOWN ON SKETCH BELOW.

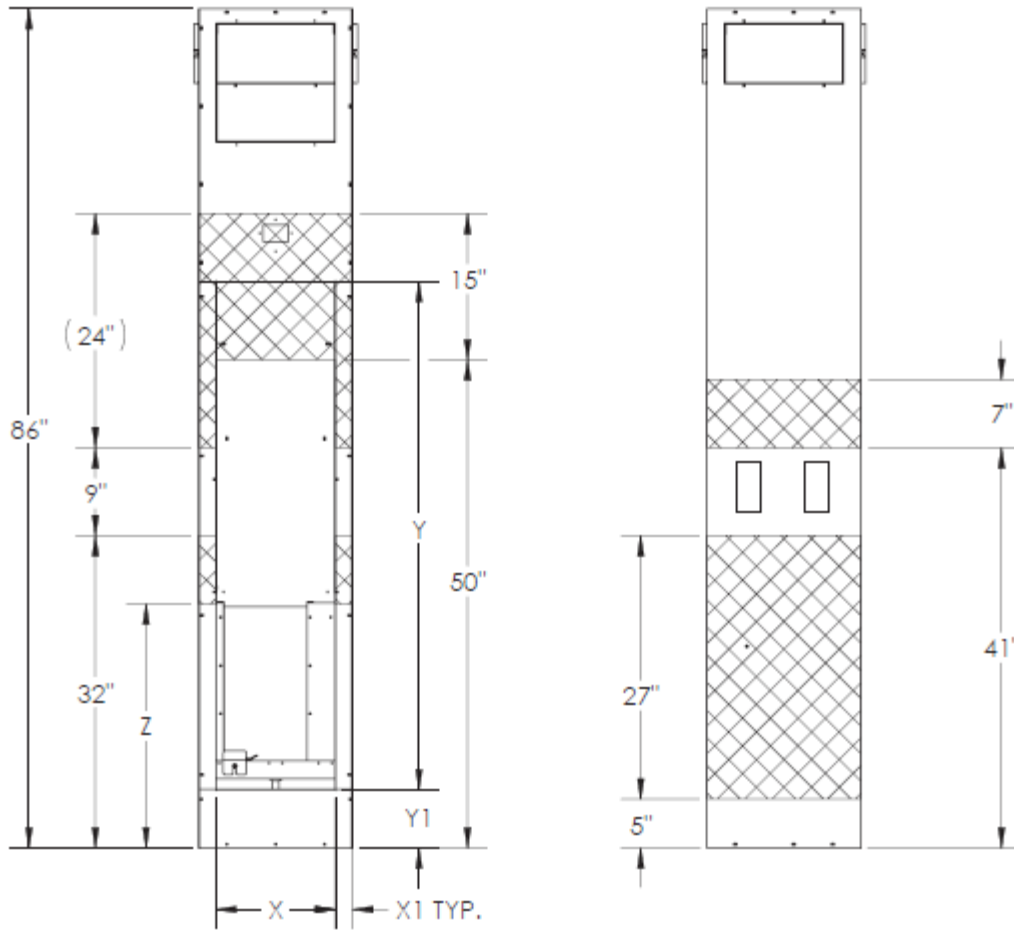

FRONT VIEW

SIDE AND BACK VIEW

	X1	X	Y	Y1	Z
300/400	1 1/4"	12 5/16"	52 1/16"	5 15/16"	25"
600/800	2 7/8"	14 5/16"	52 1/16"	5 15/16"	30"
1000/1200	2 9/16"	18 13/16"	54 1/16"	5 15/16"	30"

NOTE: THE LENGTH OF SCREW FOR INSTALLATION OF DRYWALL SHOULD NOT BE LONGER THAN 1 1/4"

17 Standard Leaf Unit Layout



Vertical Stack Fan Coil Unit - Dimensions TRS 1000/1200 - 4 Pipe Unit with ERV/HRV Module

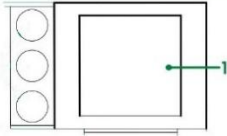

Configuration shown is Back (BK) coil, Left (LT) module, and Top Ducted SA
 Coil conn. can be: LT, RT, BK, or reverse order: RL, RR, RB
 Module can be: LT, RT, BK, with option to swap EA In/EA Out position
 OA In is always in the centre
 SA can be out the front, remaining free side, ducted, or combination there of

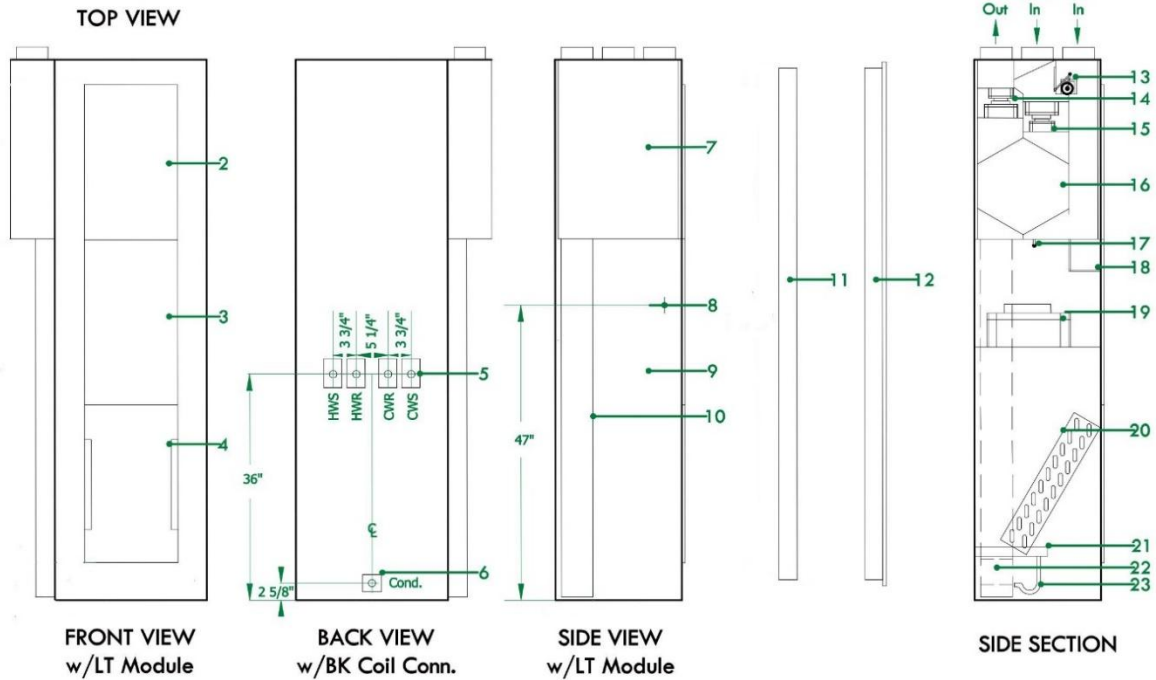

- | | |
|---|---|
| <ol style="list-style-type: none"> 1. Top duct connection knock-out
16" x 16" for nominal 1000/1200 cfm 2. Module/SA plenum access panel 3. Motor cover - allows access to motor, coil, piping package, and electrical compartment. Location of, identification, safety, and certification labels 4. RA section with flange mounted filter channel 5. Coil connections/riser stub-outs. Centered in 2.5" x 5" openings on LT, RT, or BK of cabinet (BK shown). Reversed order option available 6. Condensate/drain connection from drain pan to condensate riser 7. ERV/HRV module - shown on LT (RT and BK mounting also available) 8. Power cable entry (RT side) and control cable entry (LT side) 9. 20" ga steel cabinet, insulated with 1" acrylic coated glassfiber
1/2" closed cell cabinet insulation optional upgrade 10. 3" x 5" duct for ERV/HRV treated fresh air to return side of coil
Always located below EA out 11. Mounting flange for perimeter type RA panel. Shipped secured to unit | <ol style="list-style-type: none"> 12. Perimeter type hinged RA access panel - allows access to change filter, and removable access panels for unit maintenance 13. Outside air/exhaust air motorized damper 14. Exhaust air out fan 15. Outside air in fan 16. ERV or HRV core 17. Condensate drain - drains to unit drain pan 18. Electrical compartment 19. Backward inclined impeller fan with proportional ECM 20. 2 pipe CW cooling / HW heating coil with 6-way control valve 21. Drain pan, pitched in two directions. Acrylic coated galvanized steel
Stainless steel optional upgrade. c/w overflow float switch 22. 5" x 4" opening below drain pan for ERV/HRV intake 23. Reinforced vinyl flex hose, forms a p-trap as it exits the unit |
|---|---|

18 Model Number Reference Code

FINISHED GOODS PART #'S FOR TEMSPEC MANUFACTURED, SINGLE ZONE HVAC UNITS - NON-A2L

